



IMPULSE

IMPULSE LR

User's Manual



LIMITED WARRANTY

Laser Technology, Inc. (LTI) warrants the Impulse to be in good working order for a period of one year from the date of purchase from LTI or an authorized LTI product dealer. Should the product fail to be in good working order at any time during the warranty period, LTI will, at its option, repair or replace the product at no additional charge, except as set forth below. Repair parts and replacement parts and products become the property of LTI. This limited warranty does not include service or repair of damage to the product resulting from accident, disaster, misuse, abuse, or non-LTI modification of the product.

To activate your warranty, return the warranty card from the front of this manual to LTI within 30 days of purchase. To obtain limited warranty service, deliver the product during the one-year period to the Laser Technology Service Center and provide proof of the purchase date. If the product is delivered by mail, you agree to insure the product or assume the risk of loss or damage in transit, and to prepay the shipping container or equivalent.

LTI hereby disclaims all other express and implied warranties for the product, including warranties of merchantability and fitness for a particular purpose. (Some states do not allow the exclusion of implied warranties, so the above limitation may not apply to you.)

LIMITED WARRANTY

If the product is not in good working order as warranted above, your sole remedy shall be repair or replacement as provided above. In no event will LTI be liable to you for any damages, including any lost profits, lost savings, or other incidental or consequential damages arising from the use or inability to use such product. Furthermore, LTI shall not be held responsible if any LTI authorized dealer has been advised of the possibility of such damages, or for any claim by any other party.

Note: The Warranty Validation Card (at the front of this manual) must be completed and activated in order to benefit from this warranty. **No exceptions.**

In the unlikely event that your new LTI laser should require warranty or repair service, call us to receive a Return Merchandise Authorization (RMA) number before returning your product. Contact us at:

Laser Technology
7070 South Tucson Way
Englewood, CO 80112 USA

Phone: 303-649-1000
Fax: 303-649-9710
Web Site: www.lasertech.com

PRECAUTIONS

Avoid staring directly at the laser beam for prolonged periods of time.

The Impulse is designed to meet stringent F.D.A. eye safety requirements and is classified as eye-safe to Class 1 limits, which means that virtually no hazard is associated with directly viewing the laser output under normal conditions. As with any laser device, however, it is recommended that you avoid staring into the transmit aperture for prolonged periods while firing the laser.

Never attempt to view the sun through the scope.

Looking at sun through the scope may permanently damage your eyes.

Never point the instrument directly at the sun.

Exposing the lens system to direct sunlight, even for a brief period, may permanently damage the laser transmitter.

Do not expose the instrument to extreme temperatures.

Impulse components are rated for a temperature range of -30° C (-22° F) to +60° C (+140° F). Do not expose the instrument to temperatures outside of that range.

FOREWORD

The Laser Technology, Inc. Impulse is a light-weight, hand-held laser ranging instrument that allows you to quickly and conveniently measure distances, heights, and vertical angles. The Impulse uses sensors to measure distances and vertical angles, and menu-driven software to convert sensor readings to meaningful measurements.

The Impulse can be held easily in one hand and features simple three-finger operation: you execute most primary operations simply by sighting your target through the scope and briefly pressing one of three buttons conveniently located at your fingertips.

This manual covers the options, characteristics, and operation of these Impulse models: Impulse 200, Impulse 200LR, Impulse 100, and Impulse 100LR. Your particular Impulse may not have all the options described.

The Impulse 100 and 100LR take these measurements:

- Slope Distance
- Cumulative and Difference Distance

The Impulse 200 and 200LR take these measurements:

- Slope Distance
- Horizontal distance
- Vertical Distance
- Height
- Inclination
- Cumulative and difference distance

The LR (“long range”) models function identically to a standard Impulse, but provide longer ranging capability to non-cooperative targets.

TABLE OF CONTENTS

GETTING STARTED QUICKLY	1	TAKING A BASIC MEASUREMENT	20
BASIC IMPULSE PACKAGE	1	UNGROUPING SENSORS - IMPULSE 200.....	22
ACCESSORIES.....	1	SETTING THE SCOPE DOT INTENSITY	23
INSERTING THE BATTERIES	2	SETTING THE MEASUREMENT UNITS	23
POWERING ON AND OFF	3	PERCENT SLOPE	24
TAKING A MEASUREMENT	4	RANGE RESOLUTION	24
THE ANATOMY OF THE IMPULSE	6	POWER CONSERVATION INTERVALS.....	24
SENSORS	6	TURNING THE BEEPER ON AND OFF.....	26
SIGHTING SCOPE.....	7	TAKING A HEIGHT MEASUREMENT ...	27
FRONT AND BACK PANELS	7	HEIGHT PIVOT OFFSET	30
INSTRUMENT OPTIONS AND		ADDITIONAL NOTES	32
INDICATORS	8	<i>Calculating a Pivot Offset</i>	<i>33</i>
MEASUREMENT MODES	9	TAKING A MULTIPLE	
MEASUREMENT MODIFIERS	10	MEASUREMENT.....	34
INDICATORS / WARNINGS.....	11	DIFFERENCE MEASUREMENTS	34
SETTINGS / OPTIONS	12	CUMULATIVE MEASUREMENTS	36
ERROR CONDITIONS	14	TARGETING	39
USING THE BUTTON PANELS	15	LISTENING TO THE INSTRUMENT.....	40
SETTING UP FOR LEFT-HANDED		AIMING POINT	41
OPERATION.....	18	SETTING THE RANGE OFFSET.....	42
SWITCHING THE HAND STRAP.....	18	SETTING A GATE WINDOW	43
RECONFIGURING THE BUTTON PANELS	19	<i>Turning On the Gates</i>	<i>44</i>

TABLE OF CONTENTS

<i>Setting a Short Gate Value</i>	45	<i>Range Difference</i>	64
<i>Setting a Long Gate Value</i>	45	<i>Range Cumulative</i>	65
<i>Clearing Gate Values</i>	45	<i>Height</i>	66
USING THE FILTER OPTION.....	46	USING A TRIPOD OR MONOPOD	67
NOTES ON MEASUREMENT MODIFIERS	47	YOKE	67
THE EDIT MODE	49	YOKE MOUNT	68
DOWNLOADING DATA	51	COMPASS MOUNT	70
DOWNLOADING	51	COMPASS.....	70
THE DNLD OPTION.....	52	NOTE FOR CRITERION USERS	71
DISCARDING ERROR MESSAGES	54	CARE AND MAINTENANCE	72
OPTIONAL REMOTE TRIGGER.....	54	OPERATING TEMPERATURE	72
SERIAL INTERFACE SPECIFICATIONS	55	MOISTURE AND DUST PROTECTION	72
IMPULSE (IP200 OR IP100) FORMAT	55	SHOCK PROTECTION.....	72
<i>Queries</i>	55	CLEANING AND STORAGE	72
<i>Download Messages</i>	56	CARING FOR THE SCOPE.....	73
CR400 FORMAT.....	57	CHECKING THE DISPLAY SCREEN	73
<i>NMEA Compliance</i>	57	CHECKING THE BATTERIES	74
<i>Queries</i>	58	REALIGNING THE SCOPE	74
<i>Download Messages</i>	59	ALIGNING THE TILT SENSOR - IMPULSE 200....	76
SPECIFIC MESSAGE FORMATS	60	SPECIFICATIONS	80
<i>Version ID</i>	61		
<i>Basic Measurement & Horizontal Vector</i> ...	62		

GETTING STARTED QUICKLY

When you receive your Impulse laser instrument, check to see that you have received everything you ordered and that it all arrived undamaged.

Basic Impulse Package

- Impulse laser instrument
- Belt clip
- Hand strap
- Two AA batteries
- User's manual
- Padded carrying case

Accessories

In addition, you may have ordered one or more of these optional accessories:

- Tripod yoke and mount
- Compass and mount
- Monopod
- Two Impulse download cables:
 - Turck 4-pin to DB 9-pin cable
 - Turck 4-pin to HP 200/48 10-pin cable
- Data collector and software

Inserting the Batteries

Load the batteries by inserting them positive-end-first into the battery compartment on the Impulse's back panel.

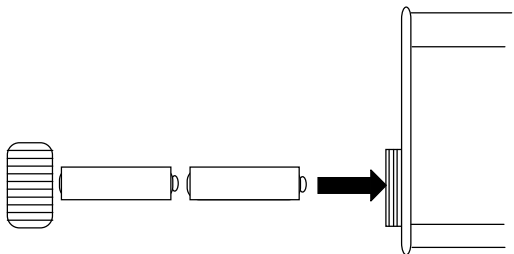

Twist the battery compartment cap clockwise, finger tight, to secure it.

Warning: Do not use the new style of AA batteries with the “voltage check” feature built into the cell.

The “voltage check” cells are slightly larger in diameter and will cause problems when inserting into and extracting from the battery compartment. The diameter of the battery tube on your Impulse was chosen carefully to allow easy in/out of normal AA batteries with no excess room for cell shifting and possible loss of contact. Note that voltage check batteries will cause similar problems with most standard metal tube AA flashlights. Laser Technology will not be responsible for damage to the unit as a result of trying to force these new style cells in or out of the battery tube. Do **not** peel off the voltage check wrapper; this can cause an instrument short circuit.

In addition, the instrument has its own battery voltage monitor, thus eliminating the need for voltage check cells.

Powering On and Off

The Impulse has a row of three buttons on either side of the instrument. Later you will learn the full use of the button panels, including setting them up for left-handed use. For a quick start at the instrument, however, power on and off by using the buttons depicted in the illustrations at the right.

Power on by pressing the rear-most button (the button closest to you) on either button panel. Power off by simultaneously pressing the two forward-most buttons on the left panel. (The instrument may also power itself off after a period of inactivity.)

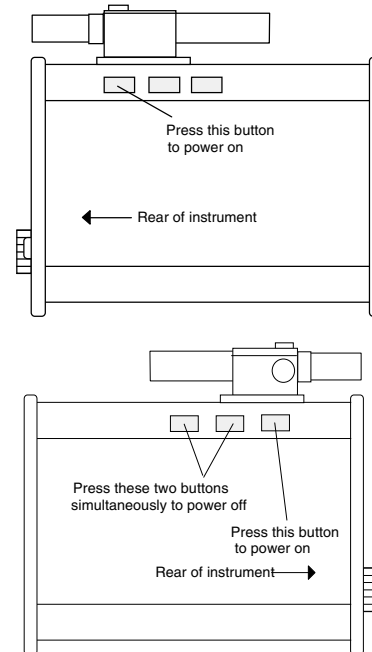

GETTING STARTED QUICKLY

Taking a Measurement

When you power on the instrument for the first time, the LCD screen on the rear panel shows this display:

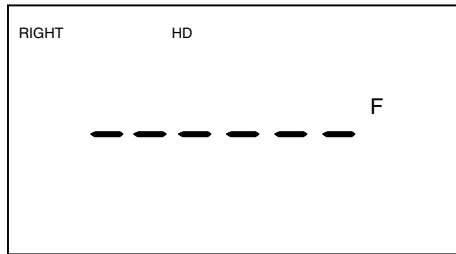

The indicator “RIGHT,” in the upper left quadrant of the screen, means you are using the right-hand button panel as your primary control panel.

The indicator “HD” means the instrument is prepared to take a horizontal distance measurement. (The slope distance indicator “SD” will appear on the Impulse 100.)

The “F” means the measurement will be taken in feet. (An “M” in this location would mean the measurement will be taken in meters.)

To take a measurement, aim to a convenient target—an interior wall will do—press the rear-most button on right panel (the same button you used to power on the instrument), and hold it down until the instrument acquires a target.

You might not notice any difference the first time you press the button; in that case, just press it again. As a power conservation measure, the red dot sighting scope

GETTING STARTED QUICKLY

automatically turns its red dot off if a measurement has not been taken within a predetermined time limit. The first press will turn on the red dot, the second press will take the measurement. You may have a fixed-crosshair scope on your Impulse, in which case two button presses are not needed to take a measurement.

After a brief delay, the instrument emits a high-pitched beep and displays something like this:

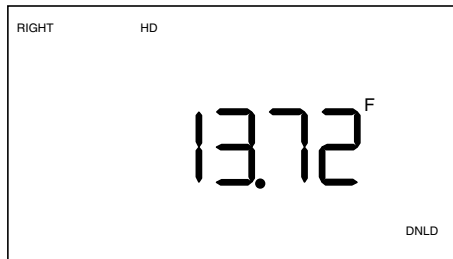

The large number in the center of the display is the distance to the target.

“DNLD” (in the lower right quadrant) means the number is available at the serial port. If you have a connection to a data logger or notebook computer, you could download the number to be stored and saved.

If you like, feel free to try some more button presses and take more measurements. The important thing for the moment is that you have experienced the Impulse’s basic point-and-shoot operation, and you have a feel for how the instrument uses indicators on the screen to let you know what operations are available to you at any given time.

THE ANATOMY OF THE IMPULSE

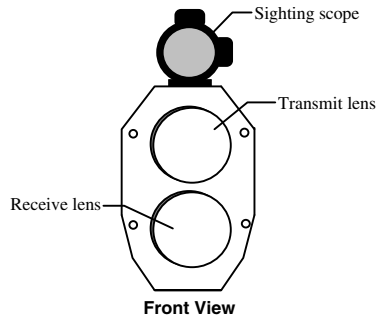

Front View

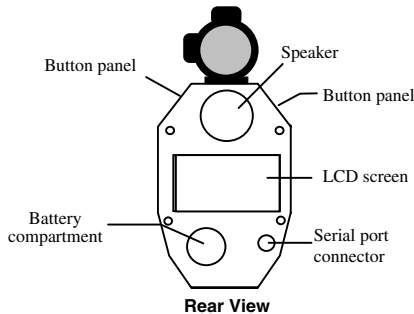

Rear View

The Impulse consists of a laser range sensor, a fluid tilt sensor (Impulse 200 only), a sighting scope, and a data output port. The sensors are integrated with software controls and accessed through the two 3-button panels on either side of the unit and a liquid crystal display (LCD) screen on the rear panel.

Sensors

The Impulse laser range sensor provides immediate access to slope distance values. The Impulse determines distance by measuring the time of flight of short pulses of infrared light. The Impulse has a broad spectrum of sensitivity and can work with both reflective and nonreflective targets.

The maximum measurement distance, about 575 meters (1880 feet), varies with target and environmental conditions.

In the Impulse 200, the tilt sensor measures vertical angles, which the Impulse uses to calculate height and elevation and to determine slope-reduced horizontal distances. The tilt sensor is capable of taking full 360 degree angular measurements, which is displayed by the tilt sensor as ± 180 degrees. The instrument held level is at 0 degrees, and is rotated up through +180 degrees, and down through -180 degrees.

Sighting Scope

The sighting scope mounted atop the Impulse will vary depending upon which option you chose.

The single-power sighting scope features an in-scope, red aiming dot to help you aim accurately to the target. You can vary the intensity of the dot to account for different

lighting conditions. See “[Setting the Scope Dot Intensity](#)” under [Taking a Basic Measurement](#).

The variable-power sighting scope features an in-scope crosshair, and allows you to adjust the magnification of the scope.

Front and Back Panels

The Impulse has two lenses on the front panel. The top lens transmits infrared laser signals. The bottom lens receives signals back from the target and feeds signal information to the instrument’s internal circuitry.

The back panel contains an LCD display screen, battery compartment access, and a serial port connector that allows you to connect the instrument to a data collector or notebook computer.

INSTRUMENT OPTIONS AND INDICATORS

The internal software of the Impulse is organized into options. Each option represents a specific Impulse measurement or setup function and has a corresponding indicator on the LCD screen. To view all of the possible Impulse indicators at once, power up the instrument by pressing the Fire or Fire2 button, **and keep the button pressed down**. This is also a good way for you to check if all the components on your display are working properly. The display will look like this:

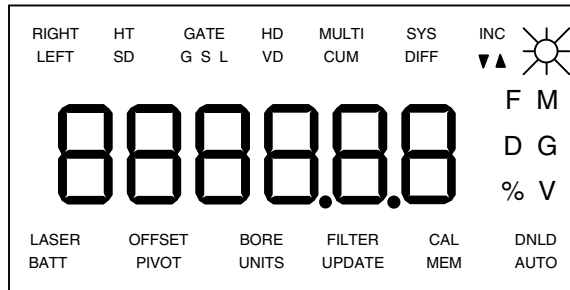

The display indicators are grouped by function, and fall into four categories: measurement modes, measurement modifiers, indicators/warnings, and settings/options. Note: Your instrument may not have all the features described.

INSTRUMENT OPTIONS AND INDICATORS

Measurement Modes

Using a laser sensor and optional tilt sensor, the Impulse can take six different types of measurements:

Indicator	Function	Explanation
HT	Height	(Impulse 200 only) Measures the height of an object
HD	Horizontal Distance	(Impulse 200 only) Measures the level distance between the Impulse and the plane of the target object
VD	Vertical Distance	(Impulse 200 only) Measures the distance between a target object and the perpendicular to the path of the horizontal distance
SD	Slope Distance	Measures the straight-line distance between the Impulse and a target object
INC	Inclination	(Impulse 200 only) Measures the angle of inclination between the Impulse at level, and the target
MULTI	Multiple Measurements	Allows the Impulse to take more than one measurement in succession CUM - maintains a cumulative distance measurement for a succession of targets DIFF - calculates the differences between a base distance and a succession of targets

INSTRUMENT OPTIONS AND INDICATORS

Measurement Modifiers

Measurement modifiers are options that can help you select or eliminate targets and help you take the most accurate measurements possible. The measurement modifiers are:

Indicator	Function	Explanation
GATE	Measurement Gate	Sets up a measurement “gate” or “window.” When gates are set, the Impulse will only measure targets that are at or beyond the window’s minimum distance, and at or within the window’s maximum distance G - Gate option is on S - Short gate is set, increasing the minimum measuring distance L - Long gate is set, decreasing the maximum measuring distance
OFFSET	Range Offset	Adds or subtracts a distance from the slope distance measurement
PIVOT	Height Pivot Offset	(Impulse 200 only) The difference between the measuring point of the instrument and the point at which it pivots to take top and base angles during hand-held height measurements
FILTER	Filter Mode	Reduces the sensitivity of the laser sensor to only detect light returned from a reflector

INSTRUMENT OPTIONS AND INDICATORS

Indicators / Warnings

These indicators impart status, warnings, or hints. They are:

Indicator	Function	Explanation
LASER	Laser	The laser sensor is firing
BATT	Battery	(Flashing) Time to replace the batteries
DNLD	Download	Measurement is available for download
▼	Down Arrow	(Flashing) (Impulse 200 only) Take base measurement in HT option or first measurement in tilt calibration
▲	Up Arrow	(Flashing) (Impulse 200 only) Take top measurement in HT option or second measurement in tilt calibration

INSTRUMENT OPTIONS AND INDICATORS

Settings / Options

The Impulse has system settings and options that allow you to use the Impulse in the most efficient and convenient way for you. The following list covers the options that are user-selected.

Indicator	Function	Explanation
SYS	System	Selects Impulse operating characteristics
RIGHT/LEFT	Right or Left	Right or left button panel is primary
BORE	Bore Sight	Aligns the red dot or crosshair in the sighting scope
CAL	Tilt Calibration	(Impulse 200 only) Calibrates the tilt sensor
UPDATE	Audio Update	(Red dot scope only) Beeper is on to indicate instrument activity and measurement result
AUTO	Automatic Download	Measurements downloaded automatically
	LED Backlight	LED backlight is on
UNITS	Units	Select measurement units F - Feet M - Meters D - Degrees G - Grads % - Percent Slope
V	Volts	Battery voltage reading

INSTRUMENT OPTIONS AND INDICATORS

Additional Note:

The middle portion of the screen, in addition to displaying measurements, is itself sometimes used as an indicator of sorts; if dashed lines appear, the instrument is ready to take a measurement; if the middle of the screen is blank, the option has suboptions that can be accessed by pressing Fire.

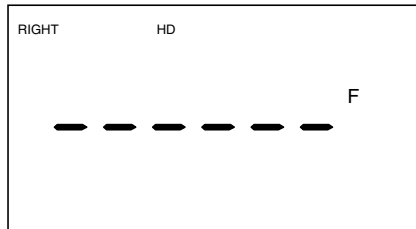

HD has no subfunctions. The dashes show where the measurement will display.

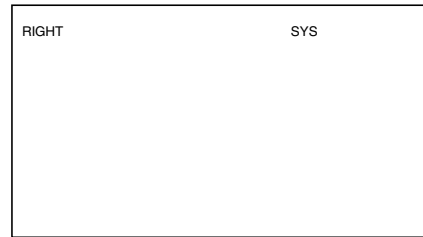

The SYS option has subfunctions; use the Fire button to enter the subprocedure.

Error Conditions

The middle area of the screen is also where error codes are displayed. If the Impulse detects an error in a measurement or download attempt, a low-pitched tone issues from the speaker and an error code displays.

The most common error is that the Impulse simply cannot find the target. Most other errors are similarly trivial; correcting them requires only that you reshoot the measurement you were trying to take, or try the download again.

You can opt to have measurements with errors discarded instead of downloaded when in the automatic download mode. See [“Discarding Error Messages”](#) in *Downloading Data*.

Code	Explanation
doF	Display overflow. The measurement exceeds the display capacity, or measurement angle at ± 90 degrees.
EoF	Editor overflow.
E01	Failure to lock on target. Reposition instrument and retake measurement.
E02	Target lost during measurement. Reposition and retake measurement.
E03	Unstable aim. Steady the instrument and retake the measurement.
E04	(Impulse 200 only) Invalid tilt sensor reading. Contact Laser Technology if error persists.
E05	(Impulse 200 only) Tilt reading outside ± 90 degree limit on % slope or height measurement. Reposition and retake measurement.
E06	(Impulse 200 only) Tilt calibration error. See the Care and Maintenance section of this manual.
E52	Temperature too hot. Stop operation.
E53	Temperature too cold. Stop operation.
E60	Calibration or code memory checksum failure.
E61	Contact Laser Technology.
E62	Contact Laser Technology.

USING THE BUTTON PANELS

You control the Impulse through two 3-button panels on either side of the instrument. One panel is always designated the primary button panel; the other, the secondary panel. You can tell which panel is primary by the LEFT or RIGHT indicator showing in the upper left quadrant of the back-panel display screen.

The two button panels are identically laid out. The button nearest the rear panel is the “Fire” button. The middle button is the “Forward” button. And the button nearest the front panel is “Back.”

In the Impulse lexicon, buttons on the primary control panel are referred to by the button name, while buttons on the secondary panel are referred to by the name suffixed with a ‘2.’ So “Fire” means

the primary Fire button; “Fire2” means the secondary Fire button.

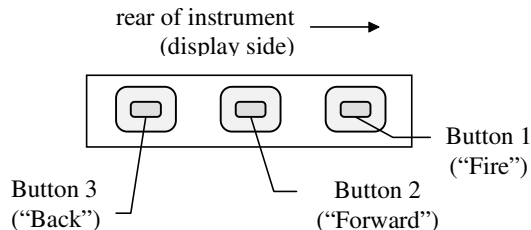

Left-side Button Panel

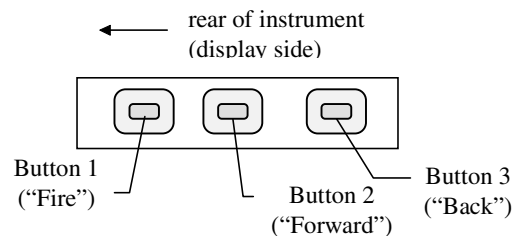

Right-side Button Panel

USING THE BUTTON PANELS

Because the Impulse features some fairly complex operations, but has a total of only six buttons to effect those operations, the specific function assigned to a button differs with:

- the operation,
- whether the button is on the primary panel or secondary panel, and
- how long you hold the button down. (A “short” press of a button simply means you press it and release it immediately. A “long” press means you press the button and hold it down for about two seconds.)

In general, Forward and Back move through menus, and Fire selects options, while the secondary buttons control the scope aiming dot and the display backlight. Specifically, the buttons have the functions indicated in the table on the next page.

USING THE BUTTON PANELS

Button	Function
Fire	<ul style="list-style-type: none"> - Powers on the instrument. - For options with submenus (HT, GATE, MULTI, SYS), selects the option. - For measurement options (SD, HD, VD, INC), initiates a measurement by firing the laser. With red dot sighting scope: the first press turns on the red dot if it is off, the second press fires the laser. - In system setup functions, selects or toggles values. - In edit mode, accepts a manually entered value.
Fire2	<ul style="list-style-type: none"> - No function in measurement operations. - In system setup functions, invokes optional “edit mode” so a value can be entered or altered. - Once in edit mode, advances to the next digit.
Forward	<ul style="list-style-type: none"> - Moves “forward” in the options in a menu. - When DNLD is showing, sends a download message out the serial port. - In edit mode, first press restores the edit value, second press abandons the edit. - Long press: sends a download message out the serial port.
Forward2	<ul style="list-style-type: none"> - With red dot sighting scope, varies the intensity of the scope dot. - When pressed simultaneously with Back2, turns off the power. - In edit mode, increments the digit value.
Back	<ul style="list-style-type: none"> - Moves “backward” in the menu (selects the previous option or “backs out” of a submenu). - Clears DNLD indicator. - In edit mode, first press restores the edit value, second press abandons the edit. - Long press: clears out the current measurement value.
Back2	<ul style="list-style-type: none"> - Turns the screen backlight on/off. - In edit mode, decrements the digit value. - When pressed simultaneously with Forward2, turns off the power.

SETTING UP FOR LEFT-HANDED OPERATION

The Impulse can be operated with equal ease by both right-handed and left-handed operators. The instrument comes configured for right-hand users but can be easily reconfigured by doing two things:

- Switching the hand strap to the left side of the instrument.
- Reconfiguring the button panels.

Switching the Hand Strap

To switch the hand strap, remove the screws that attach the strap to the mounting plates. Use the left thumb block and position the strap on the left side of the instrument so the free end of the adjusting strap is facing the rear of the instrument, and the holes in the strap base align with the holes in the mounting plates. Then simply reattach the screws.

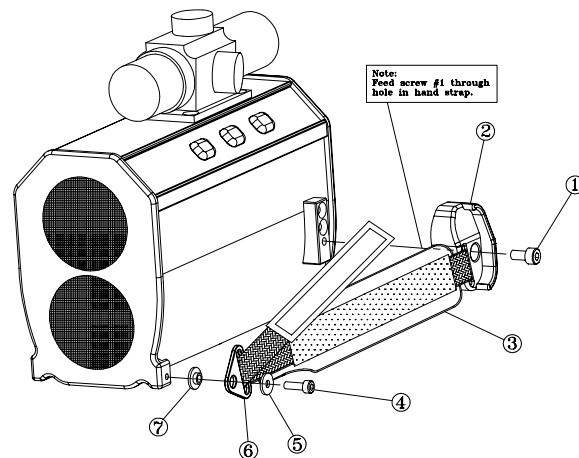

PART#	PART NAME	QUANTITY
1	Screw, M4x8	1
2	Thumb Block, Left	1
3	Hand Strap	1
4	Screw, M3x10	1
5	Flat Washer	1
6	Tri-Ring	1
7	Shoulder Washer	1

Reconfiguring the Button Panels

The Impulse has a three-button control panel on each side of the instrument. One of those panels is designated the primary panel; the other, the secondary panel. The primary panel (denoted by “RIGHT” or LEFT” in the upper left corner of the display) controls the primary functions of the instrument. The secondary panel controls ancillary functions and generally gets much less use. For easy handling, you will usually want the primary panel to be the one on the same side as the hand strap.

Follow this procedure to switch the primary panel:

1. Press the Fire button to power on the instrument.
2. Repeatedly press Forward or Back until the indicator SYS shows in the upper right quadrant of the back panel display screen.
3. Press Fire to enter the SYS submenu.
4. Repeatedly press Forward until SEL shows in the middle of the display screen, and the panel indicator begins flashing in the upper left quadrant. (This is the last item in the SYS submenu.)
5. Press Fire to toggle the primary panel between RIGHT and LEFT.
6. With the desired panel indicator showing, press Forward to accept the change. At this point, the button panels have been switched and you will need to press Back on the new primary panel to back out to the main menu.

TAKING A BASIC MEASUREMENT

The Impulse 200 takes five basic measurements. Two —slope distance and inclination—are measured directly. The remaining three—horizontal distance, vertical distance, and percent slope—are calculated. The Impulse 100 has no way to measure angles, and takes only slope distance measurements. The five measurements are related; the relationships among them are illustrated here:

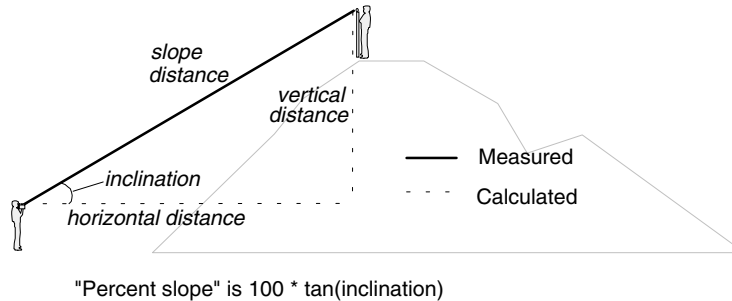

To get a feel for how the Impulse operates, choose a target near you. For the purposes of this exercise, the target can be as prosaic as, say, a wall at the end of the corridor outside your office or the fence around your back yard. Then make the button presses indicated in the table. The procedure assumes that you are starting from scratch, with the Impulse powered off.

TAKING A BASIC MEASUREMENT

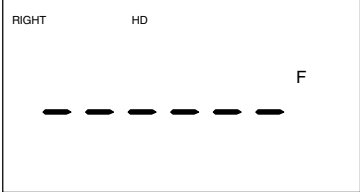
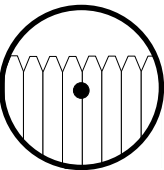
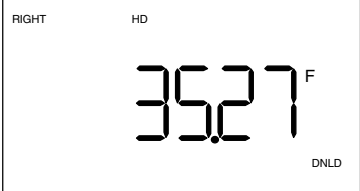
Do this...	...to get this result:
Press Fire. (The HD indicator shows on an Impulse 200; the SD indicator shows on an Impulse 100.)	 <p>The scope display shows the word "RIGHT" in the top left corner and "HD" in the top center. A horizontal dashed line is drawn across the middle of the screen. The letter "F" is positioned to the right of the dashed line.</p>
Sight the target through the scope	 <p>A circular view through a scope showing a target with vertical lines and a central black dot.</p>
Press Fire, and hold the Fire button down until the instrument locks on a target, then release	 <p>The scope display shows "RIGHT" in the top left corner and "HD" in the top center. The number "35.27" is displayed in large digits in the center. The letter "F" is to the right of the number, and "DNLD" is in the bottom right corner.</p>

You have just taken an HD (horizontal distance) measurement to your fence, or whatever target you chose. Each of the basic measurements operates in essentially the same simple way—power on, aim, and fire—except that you sometimes have a couple of other considerations.

First, the screen must be displaying the indicator for the measurement you want to take: HD for horizontal distance, SD for slope distance, VD for vertical distance, INC for inclination, etc. If the correct indicator isn't showing, press Forward until it is.

Second, if you are using a red dot sighting scope, the scope aiming dot may turn itself off after about 15 seconds of inactivity, as a power conservation strategy. If the red dot isn't showing, press Fire to turn it back on. [See *Power Conservation Intervals*, later in this section.](#)

TAKING A BASIC MEASUREMENT

this section.) If after pressing Fire the red dot still isn't showing, you probably need to adjust the intensity of the dot. [See *Setting the Scope Dot Intensity*, later in this section.](#)

Ungrouping Sensors on the Impulse 200

The Impulse 200 takes only those readings necessary to satisfy the current option. This makes it possible to “ungroup” the sensors by taking a separate reading with each sensor. Then by scrolling to another option, the instrument will combine those readings to calculate other related measurements.

For example, when slope distance (SD) is measured, only the range sensor is activated, and when inclination (INC) is measured, only the tilt sensor is activated.

Now, a horizontal distance (HD) measurement is calculated from SD, which is read by the range sensor, and INC, which is read by the tilt sensor. The straight-forward way of measuring HD is to simply shoot when the HD indicator is showing, so the instrument calculates everything at once.

But suppose, for example, that an obstruction or other unusual situation prevents you from taking a reliable reading with one or the other sensor. In that case, you can shoot an SD measurement, reposition the instrument slightly, and then take an INC measurement. Then scroll to HD, and you will see that the instrument has calculated a horizontal distance from your two separate sensor readings.

Setting the Scope Dot Intensity

The optional red dot sighting scope has six intensity settings which vary from bright to off. Adjust the red dot brightness by pressing the Forward2 button repeatedly until the desired intensity is achieved.

Setting the Measurement Units

The Impulse will express measurements either in English units or in metric units. You select the units by accessing the SYS option. Here is the procedure:

1. Use Forward and Back as needed to display the SYS indicator.
2. Press Fire to select the SYS option.
3. Press Forward repeatedly until the UNITS indicator at the bottom center of the display screen begins flashing, and SEL shows in the numeric display area.

4. Press Fire to toggle between the F (feet) and M (meters) indicators.
5. Press Forward to select F or M. The D (degrees) or G (gradient) indicator begins flashing.
6. Next, press Fire to toggle between D and G.
7. Press Forward to select D or G. The % indicator flashes, and OFF shows in the numeric display.
8. If you wish to turn on Percent Slope, press Fire.
9. Press Back twice to accept the new settings and back out to the main display.

Note: Changing your range measurement units will affect several values you may have stored in memory. The height pivot offset, range offset, and gate values will be

TAKING A BASIC MEASUREMENT

reset to zero. Basic and height measurements are cleared, and only a cumulative distance total will be converted from the current measurement units to the newly selected units.

Percent Slope

Percent slope (indicated by “%”) is a calculation equal to 100 times the tangent of the inclination angle. It is a variant way of expressing the inclination and is available on the Impulse 200 only.

An inclination angle of 5 degrees, for example, is equal to a slope of about 8.75 percent. An inclination of 90 degrees will generate the display overflow error “doF,” and inclinations that exceed ± 90 degrees will generate error “E05.”

If you have turned % on in the SYS-UNITS

option, and an inclination measurement is displayed, that measurement is a percent slope, not an inclination angle. The % indicator shows to remind you. (Note, however, that you can get percent slopes only in the basic measurement displays, never in the Height measurement displays. Note also that the instrument never downloads a percent slope. It always downloads the inclination angle. The D/G indicator indicates the units to be used in the download message.)

Range Resolution

A range value may have 1 or 2 decimal places depending on how many will fit in the six digit display. Most measurements will be resolved to two decimal places, but values larger than 9999.99 and smaller than -999.99 will only show one decimal place.

Power Conservation Intervals

To help conserve its batteries, the Impulse incorporates two timed power-off intervals, one for the scope aiming dot and one for the instrument as a whole. (The red dot interval does not affect a fixed-crosshair scope.) By default, if there is no instrument activity for 15 seconds, the scope aiming dot turns off. If there is no activity for two minutes, the instrument turns off completely.

You can change the intervals to make them more convenient for your measurement conditions. Here is the procedure:

1. Press Forward/Back as necessary to show the SYS option.
2. Press Fire to select the SYS option.
3. Press Forward repeatedly until the M

and V indicators begin flashing at the right center of the screen. The numeric display area will be showing the current interval settings, like this:

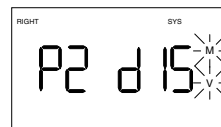

The P notation indicates the power-off interval in minutes; the d shows the scope-dot interval in seconds.

4. Press Fire repeatedly until the numeric display shows the intervals you want. Your choices are these:
 - P2 d15** power off interval = 2 minutes
scope dot interval = 15 seconds
 - P5 d15** power off interval = 5 minutes
scope dot interval = 15 seconds
 - P5 d60** power off interval = 5 minutes
scope dot interval = 60 seconds

TAKING A BASIC MEASUREMENT

ALL On both intervals full on (the instrument will not power down, and the scope dot will never turn off). Care should be taken in this mode, as it is highly power consumptive.

5. Press Back twice to accept the new settings and return to the main display.

Note: If you have turned the beeper off, the scope aiming dot turns off after every measurement, even in ALL On mode.

If the instrument powers down while you are using it, all measurements will be lost except for cumulative distance.

Turning the Beeper On and Off

Although the Impulse gives helpful audio updates that tell what the instrument is doing, you may want to turn the beeper off and use the instrument silently. This feature is available for instruments with **red dot**

scopes only. To turn the beeper on or off:

1. Use Forward and Back as needed to display the SYS indicator.
2. Press Fire to select the SYS option.
3. Press Forward repeatedly until UPDATE flashes at the bottom of the screen.
4. Press Fire to toggle the beeper on or off. When you turn it off, the ☀ flashes three times and reads "OFF." When you turn it on, the instrument beeps three times and reads "On."
5. Press Back twice to accept the new setting and back out to the main display.

If the beeper is off, the scope aiming dot automatically turns itself off after each measurement. Press Fire to turn it back on to prepare for a new measurement.

This setting will be saved upon power down.

TAKING A HEIGHT MEASUREMENT

Measuring a height presents a simple geometric problem easily within the capabilities of the Impulse 200: solve the triangle formed by the object, the ground, and the instrument.

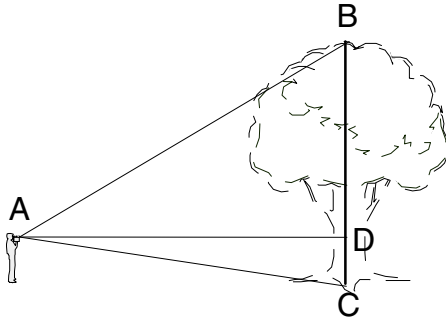

Height measurement: The instrument first calculates AD, then measures angles CAD and DAB. It then calculates BD and DC. The height is the sum of BD and DC.

The Impulse implements the process with the HT option. The option works by requiring that the measurements be taken in a specific order. The procedure is in the table on the next page; it begins by assuming the Impulse is powered off.

You will notice, by the way, that an option is often presented in the procedure surrounded by a nimbus, like this:

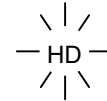

That simply indicates that, on the screen, the option will be flashing on and off. A flashing indicator shows you the measurement you need to take next; the indicator for the number being displayed also shows on the screen, but does not blink.

TAKING A HEIGHT MEASUREMENT

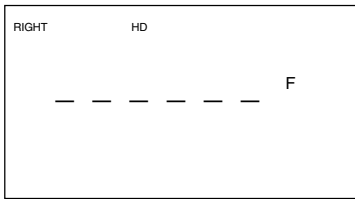
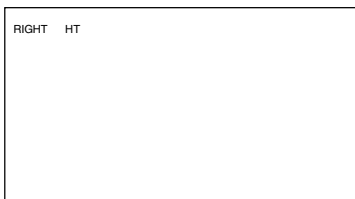
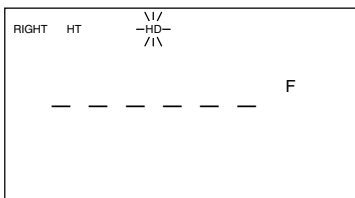
Button/Action	Result (example)
Press Fire to turn on the instrument	
Press Back to reach the Height indicator	
Press Fire to advance into the height subprocedure	

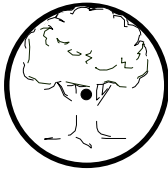
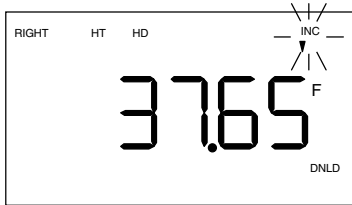
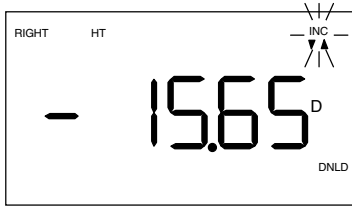
Button/Action	Result (example)
Sight the target through the scope	
Press Fire to take the horizontal distance measurement	
Aim to the base of the object (even if you can't sight it), and press Fire to take the base inclination reading	

TAKING A HEIGHT MEASUREMENT

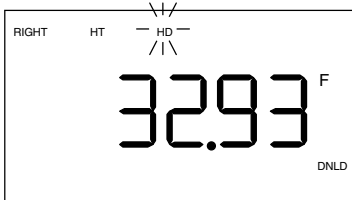
Button/Action	Result (example)
Aim to the top of the object (even if you can't sight it), and press Fire to take the top inclination reading	 <p>The LCD display shows a large digital reading of 30.72 with a small 'D' to its right. Above the reading, there are symbols for 'RIGHT', 'HT', and 'INC'. The 'HT' symbol is active, consisting of a horizontal line with a vertical line extending upwards from its center. Below the reading, the text 'DNL'D' is visible in the bottom right corner.</p>
Press Fire to display the height of the object	 <p>The LCD display shows a large digital reading of 32.93 with a small 'F' to its right. Above the reading, there are symbols for 'RIGHT', 'HT', and 'HD'. The 'HD' symbol is active, consisting of a horizontal line with a vertical line extending downwards from its center. Below the reading, the text 'DNL'D' is visible in the bottom right corner.</p>

When the procedure completes, the height calculation is showing in the middle of the screen, and the HD indicator is blinking, signifying that the instrument is prepared to take a horizontal distance measurement of

another target. At this point, you have several options:

- Pressing Forward downloads the height measurement you just took.
- Pressing Fire takes the horizontal distance measurement for another HT procedure.
- Pressing Back backs up so you can retake one or more measurements. Note that the indicators do not blink in this instance. Any measurement you retake affects the final height calculation.

To clear the HD measurement, long-press Back. Multiple short presses back you out to the main display level (which also clears the measurement).

TAKING A HEIGHT MEASUREMENT

Height Measurement Hints: The Impulse uses an HD and the two successive INC readings to calculate a height. Therefore, when taking a base or top angle reading, you don't need an actual target to shoot to since only the tilt sensor is activated. In the case of measuring a tree height, you should aim to where you think the top of the tree actually is, not just the highest point you can see.

The best heights for tapered objects (such as trees) or non-vertical objects are taken by placing a reflector directly next to the target, at the center of its girth. This insures the most accurate horizontal distance reading, thus leading to the most accurate height calculation. Filter mode is helpful in this situation.

To acquire multiple height points on a single tree (or other object) whose height you have just measured, press Back once, reshoot the top angle, then press Fire to display the new height.

Height Pivot Offset

For the most accurate possible height measurements, you should account for the difference between the measuring point of the instrument and the point at which it pivots to take the base and top angle measurements.

To take that difference into account, the Impulse provides the PIVOT option, which allows you to specify a height pivot offset. The offset is added to the slope distance measurement, enabling the instrument to

TAKING A HEIGHT MEASUREMENT

calculate a horizontal distance of the highest possible accuracy.

The measuring point of the Impulse is at the center point of the instrument. That point corresponds to the yoke mounting point, so if you are using a tripod or monopod, enter a pivot offset value of zero.

If you are using the instrument hand-held, the pivot offset is of more concern. In this case, the offset value depends upon how you hold the instrument when you take a reading. For example, you might hold it close to your face, or with your arm extended out. If you hold it so the scope is against your eye (without moving your head during a height measurement), you will want to specify the back panel as your pivot point. That means specifying a pivot offset of 0.08 meters (0.25 feet).

However, if you hold the instrument close to your eye and tilt your head during a height reading, the pivot point should be moved from the center of the instrument to the back of your head.

Depending upon the precision necessary for your height measurements, you can approximate your pivot offset value, or use the formula at the end of this chapter to calculate an exact pivot offset.

Here's how to set a height pivot offset:

1. Use Forward/Back as necessary to show the SYS option indicator.
2. Press Fire to select the SYS option.
3. Press Forward repeatedly until the PIVOT indicator in the lower left corner of the display window begins blinking, and HT is displayed in the top left of the

TAKING A HEIGHT MEASUREMENT

display window. At that point, the numeric display shows the current pivot offset value with the first digit blinking.

4. Edit in the pivot offset value in whole feet or meters using the edit function. (See *The Edit Mode* for more information.)

Note: The pivot offset cannot exceed 3 meters (10 feet), and negative values will not be accepted.

The pivot offset is now activated for all height measurements, and is denoted by the PIVOT indicator in the lower portion of the HT option display screen.

Additional Notes

Some additional notes on using the HT option and the pivot offset:

- The pivot offset is used only in height measurements. It has no effect outside the HT option.
- When you are setting the pivot offset, you can clear out the current value by long-pressing the Back button.
- If you change your mind and decide not to change the offset value after all, short-press the Back button twice to back out to the main display.
- A programmed range offset will not affect your height calculation.

TAKING A HEIGHT MEASUREMENT

Calculating a Pivot Offset

Before you can determine your pivot offset value, you need to get comfortable with taking height measurements and determine where you normally hold the instrument, be it up near your face, or with your arm extended out.

Next, pick an object whose exact height you already know (called “Height_{known}”), hold the instrument in your usual manner as determined above, and use the Impulse to measure the height. As you are measuring the height, write down these three values:

- the base inclination angle, in negative degrees (called “ θ_{base} ”)
- the top inclination angle, in positive degrees (called “ θ_{top} ”)
- the height that the instrument displays (called “Height_{laser}”)

Now, use a scientific calculator to compute your pivot offset:

$$\text{Offset}_{\text{pivot}} = \frac{(\text{Height}_{\text{known}} - \text{Height}_{\text{laser}})}{(\tan\theta_{\text{top}} - \tan\theta_{\text{base}})}$$

where “tan” refers to the tangent of the angle.

An accurate pivot offset is most critical for measurements taken at shorter distances. For the most accurate height measurements, mount the Impulse on a yoke and use a tripod or monopod, and set the pivot offset to zero.

TAKING A MULTIPLE MEASUREMENT

The multiple measurement option (MULTI) allows the Impulse to take measurements to a succession of targets. What it does with those measurements depends upon the MULTI suboption you are in at the time:

- DIFF (Difference) compares each measurement to one set point and reports the difference.
- CUM (Cumulative) accumulates the measurements and maintains a running total.

Difference Measurements

Difference measurements calculate the differences between a succession of targets and a single set point. You can use either horizontal distance measurements or slope distance measurements (Impulse 200 only).

Here's how you take difference measurements:

1. Press Forward/Back until the MULTI indicator shows in the upper right quadrant of the display screen.
2. Press Fire to enter the MULTI subprocedure. The DIFF indicator displays.
3. Press Fire to enter the DIFF subprocedure.

Impulse 100: The next display is a series of dashes, with two arrows flashing in the right corner. The instrument is now ready to accept the set point.

TAKING A MULTIPLE MEASUREMENT

Impulse 200: SEL shows in the numeric display area, and HD flashes just to the left of MULTI.

At this point, you must select whether to take all of the measurements as horizontal distances or slope distances. Horizontal distance is already selected, as shown by the flashing HD indicator. To use HD measurements, then, simply press Forward to move to the next display.

To select SD measurements, press Fire to start SD flashing. Then press Forward to move to the next display.

The next display is a series of dashes, with two arrows flashing in the right corner. The instrument is now ready to accept the set point.

4. *To set the point by laser*, aim to a suitable target and press Fire. If the aiming dot is off on the red dot scope, the first press turns it on, and you must press Fire again to measure the target.

To set the point manually, invoke the Impulse edit mode. [See *The Edit Mode for more information*](#).

Note: An edited set point cannot exceed ± 999.99 feet or meters, but a set point measured by the laser can extend to the full range of the instrument.

5. Press Forward. The numeric display area shows dashes, and the arrows turn off.

TAKING A MULTIPLE MEASUREMENT

6. Aim to a target and press Fire. Again, if the aiming dot is off on the red dot scope, the first press turns it on, and you must press Fire again to fire the laser.
7. The numeric display area shows the distance difference between the set point and the target you just measured. To download the value, press Forward.
8. Repeat step 6 for as many targets as you have. When you are finished, press Back twice to back out to the main display.

Exiting the difference measurement option will clear the difference measurement in memory.

Cumulative Measurements

A cumulative measurement lets you move from one target point to another, stopping at each one to measure the distance to the next target point. The instrument accumulates the measured distances in SD in the Impulse 100, and both SD and HD in the Impulse 200 to give you a running total.

Here's how you take a CUM measurement:

1. Press Forward/Back until the MULTI indicator shows in the upper right quadrant of the display screen.
2. Press Fire to enter the MULTI subprocedure. The DIFF indicator displays.
3. Press Forward to toggle to the CUM indicator.

TAKING A MULTIPLE MEASUREMENT

4. Press Fire to enter the CUM subprocedure.

Impulse 100: The next display is a series of dashes, with two arrows flashing in the right corner. The instrument is now ready to take the first measurement.

Impulse 200: SEL shows in the numeric display area, and HD flashes just to the left of MULTI.

At this point, you can select whether to take all of the measurements as horizontal distances or slope distances. You can toggle between the two at any time.

Horizontal distance is already selected, as shown by the flashing HD indicator. To use HD measurements, then, simply

press Forward to move to the next display.

To select SD measurements, press Fire to start SD flashing. Then press Forward to move to the next display.

The next display is a series of dashes, with two arrows flashing in the right corner. The instrument is now ready to take the first measurement.

5. Aim to a target and press Fire. If the aiming dot is off on the red dot scope, the first press turns it on, and you must press Fire again to fire the laser.
6. At this point, you have two options.
If you are dissatisfied with the measurement for some reason, repeat step 5 to retake the measurement.

TAKING A MULTIPLE MEASUREMENT

If you are satisfied with the measurement, and wish to add it to your total, press Forward. The instrument adds the current measurement to the total and displays the new total.

7. When the total is showing, you have another two options.

To simply take the next measurement without downloading, return to step 5.

To download the current total, press Forward. The arrows begin flashing again, and you may then return to step 5 for the next measurement.

In most cumulative distance measurement exercises, you will want to take a series of measurements, and download only once, when a series of related measurements are complete.

Additional Notes:

The cumulative measurement total is saved in memory even if the instrument is powered off. If you turn the instrument on and scroll back to the MULTI - CUM option, you can resume the procedure with step 7.

To clear out the current total and begin another series of measurements, long-press the Back button while the cumulative distance total is showing.

In the Impulse 200, the instrument keeps the total in both SD and HD, and you can switch between the two at any time. If you are viewing a single distance measurement on the display, press Back once and repeat step 4 to toggle between SD and HD. If you are viewing a cumulative total, press Back twice and repeat step 4.

TARGETING

When selecting a target, keep in mind that most surfaces can be measured directly. However, long distances, multiple potential targets, or lack of an actual physical object to shoot to may require additional techniques. Here are some hints, which are discussed in greater detail later in this section:

- *In the absence of a physical target*, a simple sheet of white paper suffices.
- *When shooting to near wooded or brushy areas*, use a multifaceted reflector and the instrument's filtering capability to filter out unwanted targets. We recommend a 3-inch red bicycle reflector such as a Cole model 03-3305, which is available in hardware stores. *Note:* This technique is not effective at long ranges due to the instrument's reduced sensitivity in filter mode.
- *Long ranges* are most easily acquired using a spectral or retroreflector.
- *Gating is helpful to isolate one target amongst multiple potential targets*. A measurement window can be set up to reject targets outside the range window.
- *The absolute minimum range* of the Impulse is essentially zero: in theory, you can measure objects right up against the front panel. You can increase the minimum range artificially by setting the short measurement gate.
- *The absolute maximum range* is about 575 meters (1880 feet). You can decrease the maximum range artificially by setting the long measurement gate.

Listening to the Instrument

If the audio update feature is on, the Impulse will emit a variety of ticks and tones when it takes readings (see “Turning the Beeper On and Off” under *Taking a Basic Measurement*). The sounds vary depending on what the instrument is doing, and you can tell what is happening during a measurement simply by listening. The table below explains the various sounds.

Sound	Meaning
Growl (extremely fast ticking)	The instrument is trying to lock onto a target for a range measurement. Nearly imperceptible when the instrument acquires the target immediately. When the growling quits, the target is acquired and range readings are being taken.
Double high-pitched tone	The instrument has completed the measurement, and all sensors acquired readings.
Single high-pitched tone	The instrument has completed the measurement, but one or more of the sensors failed to get a reading. The error message is indicated on the display screen.

If you’re having trouble finding a target (you will know this by the growl you hear), you can hold the Fire button down and pan the instrument around until it locates a target. The laser will try to acquire a target for up to 15 seconds, and if it is unsuccessful, it will time out and another trigger press will be needed to initiate a new measurement.

When taking a measurement, be sure to keep the trigger pressed down and hold the instrument steady until you hear the double-beep. Moving the instrument may cause inaccurate readings if the laser is shifted from one target to another during a measurement.

Aiming Point

Under certain circumstances, you may want to account for the displacement between the center of the scope lens and the measuring point of the laser instrument itself. The effect of the displacement is most noticeable at short range—generally less than 150 meters (500 feet). At ranges of more than 300 meters (1000 feet), the displacement has no practical effect.

You account for the displacement by aiming the cross hairs 7 cm (2.75 inches) above the center of the target. To ensure accurate aiming, modify a target reflector as shown or purchase a commercial lighted target with built-in offset aiming points.

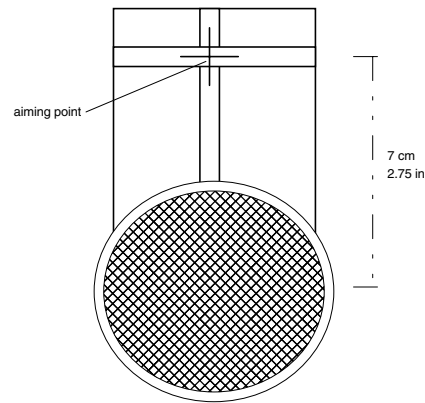

Setting the Range Offset

The Impulse has a feature that allows you to alter the measuring point of the instrument. You may want to move it closer to your target, or further away, depending upon your circumstances. For these instances, the Impulse provides the OFFSET option, which adds a distance to the slope distance measurement. Since slope distance is used to calculate horizontal distance and vertical distance in an Impulse 200, the range offset will also affect these options.

For example, if you want to measure the distance between two walls, you would put the rear plate of the Impulse up against one wall and measure the distance to the other wall. Without a range offset, the distance measured would be slightly shorter than the

actual distance, because the measuring point of the instrument is at its center. Entering a range offset of 0.09 meters (.29 feet) would move the measurement point back to the top of the battery cap (which is against the wall) and would allow you an accurate measurement from wall to wall.

Or, if the point you want to take a measurement from is inconvenient to occupy, you could shoot the distance to that point, then enter it as an offset that will be figured into all subsequent measurements.

Range offsets up to ± 999.99 may be entered. A positive offset will lengthen your measurements, or essentially move back your measurement point, and a negative offset will shorten the measurement by moving the measurement point closer to the target.

TARGETING

Here's how to specify a range offset:

1. Use Forward/Back as necessary to show the SYS option indicator.
2. Press Fire to select the SYS option.
3. Press Forward repeatedly until the OFFSET indicator in the lower left portion of the display begins blinking. At that point, the numeric display shows the current range offset value with the first digit blinking.
4. Edit in the range offset value in whole feet or meters. [Refer to *The Edit Mode* for more information.](#)

You will know that a range offset is “On” when you see the OFFSET indicator in the lower left portion of the display on SD, HD, and VD measurements. Remember, the range offset is added onto the SD

measurement, which is used to calculate HD and VD.

Setting a Gate Window

Using the Gate option, it is possible to restrict the Impulse to targeting objects within specified ranges. The ranges specified, which are always slope distance values, form the “gate window.” The range minimum is called the “short gate,” the range maximum, the “long gate.”

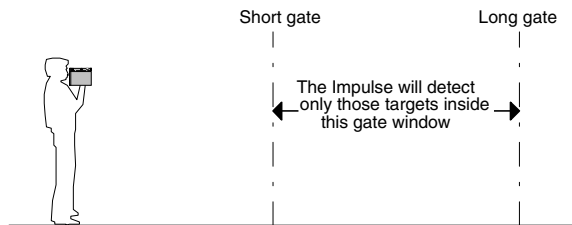

TARGETING

In essence, the gate window artificially extends the instrument's minimum range and restricts its maximum range. One of the uses of the gate window is to help you make certain you are getting the right target when objects near you or just beyond your intended target present a danger of giving you false readings.

You needn't set both gates. If you set only the short gate, for example, the gate window extends from the short gate value to the maximum range of the instrument.

The gate window is restricted to a width of 1.5 meters (5 feet). If you set the gate window too narrow, the instrument automatically adjusts it by resetting either the short or long gate, taking the most recent value entered as the standard to recalculate the other by. So if the short gate

is already set at 10 feet, for example, and then you set the long gate to 12 feet, the instrument resets the short gate to 7 feet.

A maximum value of 610 meters (2000 feet) for the short gate, and 612 meters (2005 feet) for the long gate may be entered.

You can set a gate by shooting to a target or by editing in a value. The procedure:

Turning On the Gates

1. Use Forward/Back as necessary to show the GATE indicator.
2. Press Fire to select the GATE option. The numeric display area shows the current state of the GATE option.
3. Press Fire to toggle GATE between On and OFF. If the gates already have values assigned, the S and L indicators

will display (in addition to the G indicator).

4. *To set gate values, press Forward.* The S indicator flashes and the short gate value displays. Continue to the next step.

To back out to the main display, press Back. No gate values have been set.

Setting a Short Gate Value

5. *To set the gate by laser, aim to an appropriate target and press Fire.*

To set the gate manually, use the editing function. Refer to [The Edit Mode for more information](#).

6. *To set a long gate value, press Forward.* The L indicator flashes, and the long

gate value displays. Continue to the next step.

To back out to the main display, press Back. The short gate is now set, and the S indicator is displayed in distance measurement modes.

Setting a Long Gate Value

7. *To set the gate by laser, aim to an appropriate target and press Fire.*

To set the gate manually, use the editing function. Refer to [The Edit Mode for more information](#).

8. Press Back to back out to the main display. The long gate is now set, and the L indicator is displayed in distance measurement modes.

Clearing Gate Values

If you want to clear out a gate value instead of setting it, access the value as described above and long-press Back or edit in zero.

Using the Filter Option

When you are working in an area that is crowded with potential targets, you need to make certain the instrument is detecting the right target. The best way is to use a reflector as a target and to filter out all others. To help accomplish that, the Impulse offers a FILTER option to lock onto only highly reflective targets.

Here's how you turn FILTER on:

1. Press Forward/Back as necessary to show the SYS option.

2. Press Fire to select the SYS option. The FILTER indicator begins to blink, and the current state of the FILTER option is shown in the middle of the screen.
3. Press Fire to toggle FILTER between On and OFF.
4. Press Back to save the desired setting and back out to the main display. The FILTER indicator displays in distance measurement modes to show you when the option is on.

If you have FILTER turned on, always use a reflector as a target because the instrument will reject light returned from non-reflective targets.

Notes on Measurement Modifiers

- Due to hardware constraints, gates work best when the short gate value is 5 to 6 meters (15 to 20 feet) beyond the targets you wish to reject.
- Gates can be particularly useful when trying to target an object through a window (or fog). Measuring the distance to the window, then setting the short gate 5 to 6 meters (15 to 20 feet) longer than that distance will ensure that you are targeting the object beyond the window, and not the window itself.
- When the instrument is powered off (or turns itself off), the gate option is reset to OFF, but gate values are retained in memory. Offset and filter settings are saved upon powering down.
- When using gates and offsets together, keep the following in mind: Gates and offsets are additive; a gate will reflect the same offset that is applied to the target. Say, for example, that you set the range offset to 15 meters and the short gate to 30 meters. If you scroll back to view the short gate value, it will then read 45 meters. But remember, the 45 meters is from the virtual measuring point 15 meters behind you. The gate is still 30 meters in front of you.
- The range offset has the same additive effect on the long gate setting.
- A range offset does not affect ranges in HT mode. And, although the range offset will not alter the physical location of your gates, it will alter the gate values seen on the display, so you may want to

TARGETING

clear the range offset to avoid confusion.

- Gates are applied to SD measurements only, and may not be exactly where expected in HD or VD. [See the diagram in the beginning of *Taking a Basic Measurement* to clarify the relationship between these measurements.](#)

THE EDIT MODE

The Impulse has an editor which can be used to manually enter numeric values for the range offset, gate distances, the set point of difference distance measurements, and in the Impulse 200, the height pivot offset and tilt calibration offset.

The range offset, height pivot offset, and tilt calibration offset are always input manually, and entering these submenus automatically invokes the editor.

When it is more desirable to manually input gate distances and the set point of difference distance measurements rather than shooting them in with the laser, an optional editor is available by pressing Fire2 when a distance measurement is requested by the Impulse.

Once in the editor, follow this method:

- The left-most digit will be flashing. Press Forward2 or Back2 to toggle the first digit between zero (which represents a positive value) and the minus sign (-). Negative values are not allowed for a height pivot offset.
- Fire2 advances the edit to the next digit to the right. Use Forward2 and Back2 to increment or decrement the value of the digit. Repeat this step as necessary to advance through each digit in the entire distance value and edit each digit individually.

The distance value can be cleared to zero at any time by long-pressing the Back key. Once altered or cleared, the original distance value can be restored by pressing either Forward or Back.

THE EDIT MODE

When your edited value is correct, press Fire. A beep will sound, and the value will be accepted in memory and at this point can no longer be restored by pressing Forward or Back. To exit the editor and return to your submenu, press Forward or Back.

***Note:* If you exit out of the editor without pressing Fire, your edit will not be saved!**

DOWNLOADING DATA

The Impulse back panel contains a 4-pin serial connector that allows you to download data to a data collector or notebook computer. The accessories needed for remote operations—cables and a data collector—are available from LTI.

Current data collection software packages for the laser include LTI Map, LTI Face Profiler, and Traverse PC Handheld. Available interfaces for GPS mapping systems include Ashtech Reliance, Trimble Pathfinder, and CMT MC-GPS. Please call us for more information on application software.

Downloading

Measurement data can be downloaded using one of three methods: manual download, automatic download, or query.

The data you wish to download must appear in the display window for either instrument invoked or requested data to be valid. If there are no measurements available to download, the instrument downloads null or zero values.

When a measurement is available, the DNLD indicator displays. In that case, you can download by query or manually by short-pressing Forward. A successful download will be noted by a flashing DNLD indicator, then it will disappear. Even if the DNLD indicator is not showing, downloading is always available by long-pressing the Forward button.

The automatic download mode, when activated, downloads values automatically

DOWNLOADING DATA

every time the instrument takes a measurement.

The download messages can take one of two formats: the Impulse native format or, for those who already have download software designed for the Criterion family of instruments, the Criterion 400 format. The Impulse native format comes from LTI's Impulse series of instruments, and is denoted by IP200 in the Impulse 200, and IP100 in the Impulse 100.

The DNLD Option

You set the automatic download mode, and change the download format, with the SYS - DNLD option. Here is the procedure:

1. Use Forward and Back as needed to display the SYS indicator.
2. Press Fire to select the SYS option.
3. Press Forward repeatedly until the DNLD indicator appears in the lower, right corner of the display window, and On or OFF shows in the numeric display area. The AUTO indicator will also show, but will be blinking.
4. Pressing Fire toggles between turning the auto download feature 'On' and 'OFF.'
5. Press Forward to select On or OFF. The AUTO indicator disappears and the numeric display area shows the download message format setting (CR400, or IP200 or IP100).
6. Press Fire to toggle between CR400 and IP200/IP100.

Impulse 100: While CR400 is showing, you have the option of pressing Fire2 to toggle the range units (F or M) and angle indicator (D) on and off. (Either F or M will be displayed, depending upon which range units you have selected.)

With F/M and D both off, all fields download as null except for SD. Turning F/M on downloads an SD value in the horizontal distance field, and 0.00 in the inclination field with a valid measurement. Turning both F/M and D on will download an SD value in the horizontal distance field, and will download 0.00 in both the inclination and azimuth fields. This is to accommodate download software that does not accept null values.

Impulse 200: While CR400 is showing, you have the option of pressing Fire2 to toggle the D or G indicator on and off. (Either D or G will be displayed, depending upon which units of angular measurement you have selected.) With D (or G) on, the azimuth field in the Criterion horizontal vector message will download as 0.00; with D (or G) off, it downloads as null. This is to accommodate download software that does not accept null values for azimuth.

7. Press Back twice to back out to the main display and save the DNLD settings.

The DNLD options are set and will come up the next time you power on the instrument.

Discarding Error Messages

When using the automatic download mode, you can choose whether to download every measurement, with or without null data from error conditions, or to download valid measurements only.

Set this preference by scrolling to the SYS-Err option and press Fire to toggle the feature on, to download both measurement values and null data, or off, to download valid measurements only.

Optional Remote Trigger

It is possible to remotely trigger the Impulse and take a measurement by using an external computer, data collector, or switch closure. Remote triggering is accomplished by providing an open collector closure to ground or an active low TTL or RS232 level

signal to the 'trigger' pin on the serial connector. This option requires a special order download cable that connects the remote trigger signal from the Impulse to the 'RTS' output signal of a computer's serial port.

When using a serial cable with a remote trigger connection, care must be taken in controlling the state of the RTS signal from the host computer. Often times the default state of the RTS signal will be low, causing an inadvertent trigger of the Impulse. Since the remote trigger signal is treated the same as a keypress on the Impulse keypad, holding the signal low is identical to holding down a function key, which prevents a response to any additional keys that are pressed.

DOWNLOADING DATA

With the red dot sighting scope, if the red dot is off when the remote trigger is activated, it is not necessary to trigger twice to first turn on the dot and then take a measurement. The remote trigger will turn on the scope aiming dot and take a measurement all at once.

Serial Interface Specifications

The Impulse serial interface uses RS-232 +/-12V signal levels and data format. The format parameters are set to:

- 4800 bps (CR400 format)
- 9600 bps (IP200 and IP100 format)
- 1 start bit
- 8 data bits
- 1 stop bit
- no parity

Pin-out assignments for the Impulse serial port are:

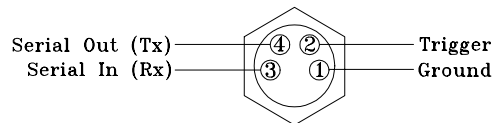

Impulse (IP200 or IP100) Format

Queries

The data you wish to download must appear in the display window. If it does not, scroll to the appropriate option. An Impulse format query message from the download device to the Impulse is in this general format:

\$datatype <CR>

DOWNLOADING DATA

where:

datatype

is the kind of data you are requesting. Legal values:

\$ID = Instrument version number

\$BM = Basic measurements

\$HT = Height data (Impulse 200 only)

\$RD = Range difference

\$RC = Range cumulative

<CR> is a carriage return character.

An invalid query will return error message: \$ERR

Download Messages

Data messages downloaded in IP200/IP100 format are in this general form:

*\$datatype, value,... dunits, aunits *csum <CR>*

where:

datatype

identifies the data type. Legal values:

\$ID = Instrument version number

\$BM = Basic measurements

\$HT = Height data (Impulse 200 only)

\$RD = Range difference

\$RC = Range cumulative

value,...

are the values associated with the data type, separated by commas. The last value in the list is followed by a comma.

A value may have 1-2 decimal places, depending on how many will fit in a six-digit measurement. The maximum value for any measurement is 99999.9; the minimum is -9999.9. Since the instrument cannot measure more than a

DOWNLOADING DATA

few thousand feet, the maximum possible values can only be obtained through cumulative distance measurements or by using a large offset.

dunits

specifies the units for distance measurements.

Legal values:

F=feet

M=meters

aunits

specifies the units for angular measurements.

Legal values:

D=degrees

G=grads (Impulse 200 only)

**csum*

is an asterisk followed by a hexadecimal checksum. The checksum is the result

of a complemented, no-carry, binary addition of all the characters between the dollar sign and the asterisk.

<CR> is a carriage return.

CR400 Format

NMEA Compliance

The Criterion 400 data format follows the guidelines of the NMEA 0183 Standard for Interfacing Marine Electronic Navigational Devices, Revision 2.0.

NMEA 0183 provides for both standard and proprietary data formats. Since none of the standard formats are useful for the data transferred from the Impulse, special proprietary formats are used. Rules described in the NMEA standard governing general message structure, leading and

DOWNLOADING DATA

trailing characters, numeric values, delimiting character, checksums, maximum line length, data rate, and bit format are followed exactly.

As required by NMEA 0183, the CR400-format does not respond to unrecognized header formats, malformed messages, or messages with invalid checksums.

Queries

The data you wish to download must appear in the display window. If it does not, scroll to the appropriate option. A CR400-format query message from the download device to the Impulse is in this general format:

\$PLTIT,RQ,datatype <CR><LF>

where:

\$PLTIT,RQ,

identifies this as a CR400-format request message.

datatype

identifies the type of data you are requesting. Legal values:

ID = Instrument version number

HV = Horizontal vector

HT = Height data (Impulse 200 only)

RD = Range difference

RC = Range cumulative

<CR><LF> is a carriage return/line feed combination.

If the optional NMEA query checksum is used, the Impulse will ignore it.

DOWNLOADING DATA

Download Messages

In CR400 format, the Impulse downloads data messages in this general form:

\$PLTIT, *datatype* , *value*, *units*, ... * *csum*

where:

\$PLTIT,

is the Criterion message identifier.

datatype,

is the data type. Legal values:

ID = Instrument version number

HV = Horizontal vector

HT = Height data (Impulse 200 only)

RD = Range difference

RC = Range cumulative

value, *units*, ...

specifies a measurement value and the units in which that value is expressed. This pattern repeats as often as needed

to specify the downloaded values, except that the final units designator is not followed by a comma.

A value may have 1-2 decimal places, depending on how many will fit in a six-digit value. The maximum value for any measurement is 99999.9; the minimum is -9999.9. Since the instrument cannot measure more than a few thousand feet, the maximum possible values can only be obtained through cumulative distance measurements or by using a large offset.

Each unit designator is a one-character indicator. Legal values are:

F=feet

M=meters

DOWNLOADING DATA

D=degrees

G=grads (Impulse 200 only)

**csum*

consists of an asterisk followed by a two-digit hexadecimal checksum. The checksum is calculated by XORing the eight binary data bits of each character between the dollar sign and the asterisk.

<CR><LF>

is a carriage return/line feed.

An invalid query will not be responded to by the instrument.

Note: Historically, the HV data line has been the most commonly used of all Criterion 400 data line types, and hence is the only data line type supplied in the Impulse.

Specific Message Formats

The table on the following page shows example message formats for each data type, in both CR400 and IP200/IP100 format.

The examples in the table use these values and units:

HD: 22.58 feet (IP 200 only)

SD: 27.5 feet

VD: 15.7 feet (IP 200 only)

INC: 34.79 degrees (IP 200 only)

HT: 37.02 feet (IP 200 only)

RD: 41.00 feet (set point)
-1.35 feet (difference)

RC: 208.34 feet (HD total - IP 200 only)
244.00 feet (SD total)

DOWNLOADING DATA

Version ID

Impulse Model	IP200-format Message	CR400-format Message
200	Query: \$ID Response/download: \$ID,IP200,1.40*2C	Query: \$PLTIT,RQ,ID Response/download: \$PLTIT,ID,IP200,1.40*44

Impulse Model	IP100-format Message	CR400-format Message
100	Query: \$ID Response/download: \$ID,IP100,1.40*2D	Query: \$PLTIT,RQ,ID Response/download: \$PLTIT,ID,IP100,1.40*47

DOWNLOADING DATA

Basic Measurements and Horizontal Vector

Impulse Model	IP200-format Message	CR400-format Message
200	Query: \$BM Response/download: \$BM,27.5,34.79, ,22.58,15.7,F,D*17 <i>(Note: empty field is azimuth value)</i> Bad reading or null data: \$BM, ,34.79 , , ,F,D*AD \$BM, , , , ,F,D*B2	Query: \$PLTIT,RQ,HV Response/download: \$PLTIT,HV,22.58,F, , ,34.79,D,27.5,F*39 <i>(Note: empty field is azimuth value)</i> Response/download with dummy azimuth field: \$PLTIT,HV,22.58,F,0.00,D,34.79,D,27.5,F*63 Bad reading or null data: \$PLTIT,HV, , , , ,34.79,D, ,*04 \$PLTIT,HV, , , , , , , ,*67

DOWNLOADING DATA

Basic Measurements and Horizontal Vector (continued)

Impulse Model	IP100-format Message	CR400-format Message
100	Query: \$BM Response/download: \$BM,27.5, , , , ,F,D*E6 Bad reading or null data: \$BM, , , , ,F,D*B2	Query: \$PLTIT,RQ,HV Response/download: \$PLTIT,HV, , , , , ,27.5,F*3F Bad reading or null data: \$PLTIT,HV, , , , , ,*67 Response/download with dummy HD field: \$PLTIT,HV,27.5,F, , ,0.00,D,27.5,F*3D Response/download with dummy HD & azimuth fields: \$PLTIT,HV,27.5,F,0.00,D,0.00,D,27.5,F*67 Bad reading or null data with dummy HD & azimuth fields: \$PLTIT,HV, , , ,0.00,D, , , ,*3D

DOWNLOADING DATA

Range Difference

Impulse Model	IP200-format Message	CR400-format Message
200	Query: \$RD Response/download: \$RD,41.00,-1.35,F*B8 Bad reading or null data: \$RD,41.00, ,F*AC \$RD, , , *E5	Query: \$PLTIT,RQ,RD Response/Download: \$PLTIT,RD,41.00,F,-1.35,F*70 Data unavailable: \$PLTIT,RD, , , *6F

Impulse Model	IP100-format Message	CR400-format Message
100	Query: \$RD Response/download: \$RD,41.00,-1.35,F*B8 Target measurement only: \$RD,41.00, ,F*AC Bad reading or null data: \$RD, , , *E5	Query: \$PLTIT,RQ,RD Response/Download: \$PLTIT,RD,41.00,F,-1.35,F*70 Target measurement only: \$PLTIT,RD,41.00,F, ,*02 Bad reading or null data: \$PLTIT,RD, , , *6F

DOWNLOADING DATA

Range Cumulative

Impulse Model	IP200-format Message	CR400-format Message
200	Query: \$RC Response/download: \$RC,208.34,244.00,F*49 Data cleared to zero: \$RC,0.00,0.00,F*24	Query: \$PLTIT,RQ,RC Response/download: \$PLTIT,RC,208.34,F,244.00,F*67 Data cleared to zero: \$PLTIT,RC,0.00,0.00,F*02

Impulse Model	IP100-format Message	CR400-format Message
100	Query: \$RC Response/download: \$RC, ,244.00,F*78 Data cleared to zero: \$RC, ,0.00,F*E2	Query: \$PLTIT,RQ,RC Response/download: \$PLTIT,RC, , ,244.00,F*32 Data cleared to zero: \$PLTIT,RC, , ,0.00,F*30

DOWNLOADING DATA

Height

Impulse Model	IP200-format Message	CR400-format Message
200	Query: \$HT Response/download: \$HT,37.02,F*CB Data unavailable: \$HT, ,*0B	Query: \$PLTIT,RQ,HT Response/download: \$PLTIT,HT,37.02,F*0B Data unavailable: \$PLTIT,HT, ,*65

USING A TRIPOD OR MONOPOD

Laser Technology, Inc. can supply accessories that allow you to mount the Impulse on a tripod or monopod.

The accessories are:

- yoke and mounting bracket
- compass and compass mount

Yoke

The yoke features an open design to allow you to mount the Impulse to the pod without interfering with the operation of the buttons.

To help you level the instrument, the yoke has a bubble level. To achieve level, make sure the bubble is centered in the indicator circle.

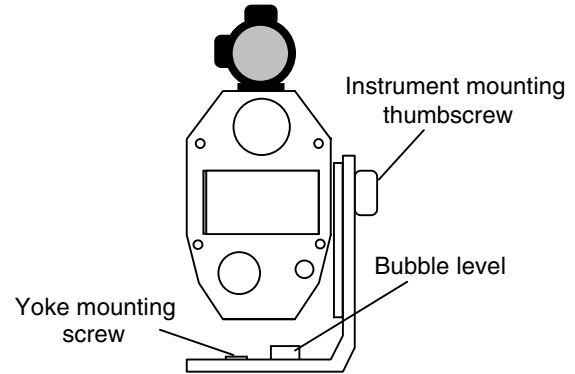

USING A TRIPOD OR MONOPOD

Yoke Mount

The yoke mounting bracket attaches to the Impulse on the side opposite the hand strap. Simply screw it into place.

If you are switching the hand strap from one side to another, you will also need to reconfigure the yoke mounting bracket for use on the opposite side.

PART#	PART NAME	QUANTITY
1	Yoke Plate	1
2	Shaft Adapter	1
3	Yoke Mount Block	1
4	Screw, M3x10	4
5	Split Ring Lock Washer	4
6	Screw, M4x8	1
7	Screw, M3x16	1

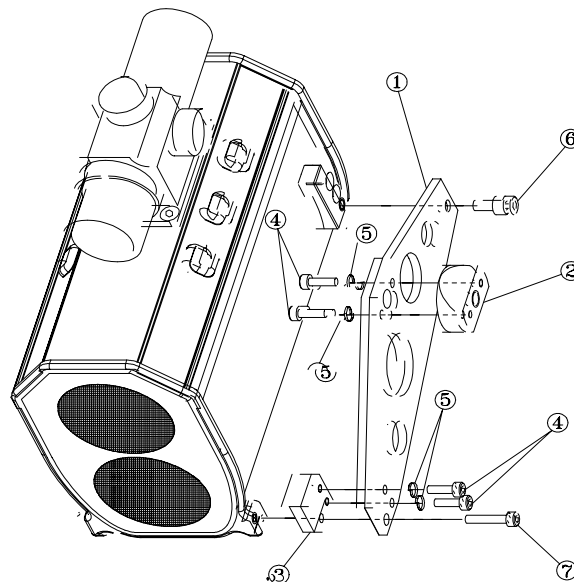

USING A TRIPOD OR MONOPOD

To attach the instrument to a tripod or monopod, first attach the mounting bracket to the side of the instrument, then attach the yoke to the pod. Align the thumbscrew with the middle hole in the attachment at the top of the bracket, and tighten the thumbscrew.

To adjust the friction, tighten the thumbscrew into the yoke mount, and adjust the nut as needed.

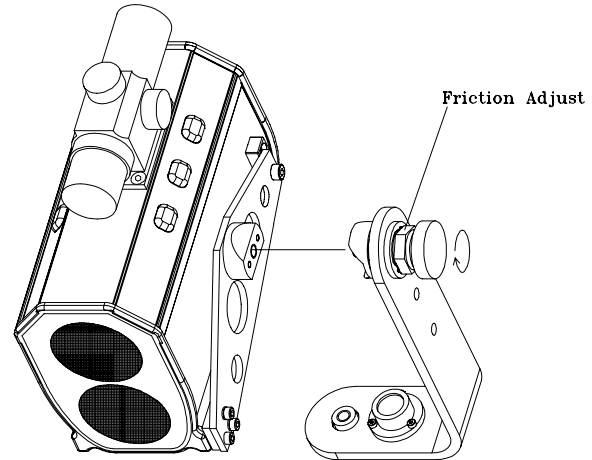

Compass Mount

The compass mount attaches to the yoke and extends over the top of the mounted instrument. On top of the mount is a housing that fits over the Suunto compass and holds it in place.

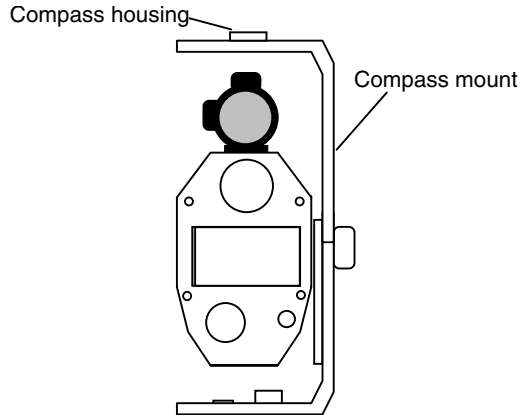

Compass

The compass features two hairlines, one of which is movable. The fixed hairline is for reading the magnetic bearing; the movable hairline is for reading a bearing corrected for declination.

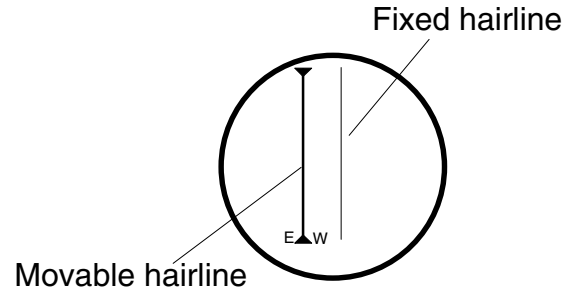

USING A TRIPOD OR MONOPOD

You must set the movable hairline to account for the declination in your area. If you are using a Suunto KB-14D compass, set the declination crosshair by moving it east or west of the magnetic crosshair by half the number of degrees of the declination value. For example, if the declination in your area is 10°E, set the movable hairline so it is 5 degrees to the left of the fixed hairline. If the declination is 10°W, set the movable hairline 5 degrees to the right of the fixed hairline. Test this on a target and take readings with each line to ensure that you get the full value between the two azimuths. If you are using a different compass, please refer to the manufacturer's instructions for setting declination.

Note for Criterion Users

If you are using a Criterion staff, subtract 5 inches (0.42 feet) from the number silk-screened at the bottom of the staff.

Operating Temperature

The instrument components are rated for a temperature range of -30° C (-22° F) to 60° C (140° F). Do not expose the instrument to temperatures outside that range.

Moisture and Dust Protection

The instrument is sealed to provide protection from normally expected field conditions. It is protected from dust and from rain, and features temporary submersion resistance.

Shock Protection

The Impulse is a precision instrument and should be handled with care. It will withstand a reasonable drop shock. If you drop the instrument, however, check the scope and tilt alignment (Impulse 200 only)

before using the instrument for measurement.

Cleaning and Storage

Clean the instrument after each use, before returning it to its case. Check for all the following items:

- *Excess moisture.* Towel off excess moisture, and air dry the instrument at room temperature.
- *Exterior dirt.* Wipe exterior surfaces clean. Use isopropanol to remove dirt and fingerprints from the scope exterior.
- *Dirty lenses.* Use a lens brush to remove surface dust and loose particles from the front panel lenses. Clean each lens by moistening it with a lens cleaning solution and wiping it with a

clean cloth or lens tissue. If paint splatters on a lens, let it dry and carefully pick off the dried paint with your fingernail.

- *Batteries.* If you won't be using the instrument again soon, remove the batteries before storing it.

Caring for the Scope

Do not attempt to lubricate the scope. It is sealed from within using O rings and special compounds. All seals are permanent and require no maintenance.

Clean the lenses with lens cleaning solution and a soft, dry cloth or lens tissue. Use a lens brush to remove surface dust and loose particles. Remove paint splatters by

letting them dry and carefully picking them off with your fingernails.

The windage and elevation adjustment screws are permanently lubricated; do not attempt to lubricate them. Keep the turret caps on except when you are aligning the scope.

Checking the Display Screen

It is a good idea to periodically check the display screen to make certain that all display segments still show up. You can do that by powering on as usual, but instead of releasing the Fire button immediately, hold it down. For as long as you hold the button, all segments of the display should show, allowing you to identify any that no longer display.

[See *Instrument Options and Indicators*](#)

for a complete drawing of all display indicators.

While you are holding the fire button, you can also display the Impulse instrument version number by pressing any other button.

Checking the Batteries

You can check the battery voltage level by scrolling to the SYS - BATT option. The numeric display area shows the current voltage reading of the batteries.

Should the batteries run low during measurement operations, the BATT indicator blinks. If you continue operations, and the batteries run down further, a Lob message displays on the screen.

If you fail to change the batteries at that point, the keys will lock out.

Realigning the Scope

The scope may become misaligned by a heavy blow to the instrument. Periodically follow the procedure in the table below to verify that the laser beam is hitting its target and to correct it, if necessary. The point of the procedure is to align the laser's point of impact with the scope's aiming dot or crosshair, using sound to indicate when the scope is on target.

To align the scope properly, you need:

- *A flat-head screwdriver* to turn the scope adjustment screws.
- *A target* at which to aim the instrument.

CARE AND MAINTENANCE

- A *highly stable base* for the instrument. A tripod is recommended.

The target that you choose is critical to the success of the alignment operation. It should be a reflecting target large enough to be seen clearly from a distance but small enough to be a highly accurate indicator of where the laser beam is hitting. A bicycle reflector at least three inches in diameter is recommended.

The target should be positioned at least 90 meters (300 feet) from the instrument and isolated from other targets. Ideally, the target, when viewed from the instrument's position, should be silhouetted against the sky, with no other targets in the immediate vicinity. (That's so you can be certain of the general area the laser is hitting.)

Finally, make certain you know the scope's definition of which way is up. To adjust the scope UP (marked L) turn the screw clockwise. To adjust the scope RIGHT (marked UP) turn the screw counter-clockwise. For example, if you're hitting above the target, you want to lower the scope to meet the target, so adjust the screw DOWN.

Action	Notes/Explanation
Position the target.	You need an isolated, reflecting target at least 90 meters away. It should be visible, but should present as small a target area as possible.
Position the instrument.	Use a stable tripod that allows easy movement of the instrument in two planes.

Go to SYS/BORE	“tt” is displayed.
Aim at the center of the target and hold down the Fire button.	The instrument emits a tone. The frequency varies as you move the instrument.
Slowly pan the Impulse horizontally and vertically. When the tone drops from high to low, note the position of the target relative to the aiming dot or crosshair.	If the frequency drops off at equal distances from the center of the aiming dot or crosshair, the instrument needs no adjustment. Otherwise, continue with the next step.
Unscrew and remove the turret caps.	
Adjust elevation and windage until the frequency drops off when the target is at equal distances from the center of the aiming dot or crosshair.	Each tick mark on an adjustment screw equals one minute of angle (MOA). Adjust carefully. Make sure you’re moving the dot or crosshair in the right direction before you try adjusting in large increments.
Check the alignment one last time. Then replace the turret caps and power down the instrument.	

Aligning the Tilt Sensor on the Impulse 200

Periodically check, and realign if necessary, the instrument’s tilt sensor using the CAL suboption in the SYS menu. The process of “aligning” the sensor involves finding out how far off it is, and recording an offset value that accounts for the discrepancy. The basic idea behind the procedure is simple: you are aligning a target level with the scope and forcing the instrument to measure an inclination angle of zero.

Different methods of tilt calibration offer varying degrees of precision, and you can determine which to use based on the level of accuracy required for your measurements. The first method, the subtractive offset, requires a precision surveying level that helps you position a

target precisely level with the Impulse scope. If you do not have such an instrument, use one of the additive offset methods, such as the “desktop” additive offset, which is also the factory calibration method, or the “opposed targets” additive offset procedure, which is described after the desktop method.

Computing the subtractive offset value requires this procedure:

1. If necessary, realign the scope.
2. Make sure the instrument reads degrees and percent slope is turned off.
3. Position the scope so its center is aligned with a previously determined level target. *Note:* The scope must be

properly aligned for this calibration to be accurate.

4. Take an inclination measurement and note down the value.
5. Return to the SYS - CAL option, and press Fire2 to enter the editor.
6. Edit in the value.
7. Return to the INC option and measure the same target again. The inclination measurement should be 0.00.

To compute the additive offset, follow this procedure:

1. Make sure the instrument reads degrees and percent slope is turned off.
2. Set your power conservation interval to 5 minutes/60 seconds or ALL On.

CARE AND MAINTENANCE

3. Clear the range offset to zero.
4. Scroll to the SYS option and press Fire.
5. Press Forward until CAL begins blinking in the lower right portion of the display window and the center of the display screen shows dashes.
6. Press Fire2 to display the subtractive offset value.
7. Long-press Back to clear the value, and press Fire to accept the cleared value.
8. Place the instrument on its base on a level desk or table. Align the long edge of the instrument with the edge of the desktop or tabletop.
9. Press Fire. (The first press may turn on the scope dot; if the instrument does not begin a series of regularly spaced tones, press Fire again.)
You will have two seconds to stabilize and quiet the instrument before any measurement is taken.
10. Rotate the instrument precisely 180 degrees and press Fire once more. Again, you will have two seconds to stabilize and quiet the instrument before any measurement is taken.
11. Press the Fire button. The instrument computes and displays a tilt offset value. Press Fire to use the computed value.
12. Scroll back to the main display, and scroll to the INC indicator. Take two inclination readings, using the same desktop and rotation procedure used

previously. The two readings should be within 0.05 degrees one another.

13. Reset your power conservation interval to that of normal usage.

Note: The additive offset procedure can be performed with a higher degree of accuracy by setting up two targets 15 to 30 meters (50 to 100 feet) away. The center of each target must be level with the center of the scope lens, and they must be facing each other. This procedure requires an accurately aligned scope. Follow the same procedure, but instead of placing the instrument on a desk or table, place the instrument on a stable platform at one end of the alignment area, and shoot to the opposite target. These two readings should also be within 0.05 degrees of one another.

SPECIFICATIONS

Note: these specifications are subject to change.

Weight:	1 kg (2.2 lb.)
Size:	15.2 x 6.4 x 12.7 cm (6 x 2.5 x 5 in)
Max Range:	575 meters (1880 feet) to a cooperative target
Target Ranges:	Impulse 100/200: 50 meters to overhead cable/stake 250 meters to rock face/building
	Impulse 100LR/200LR: 100 meters to overhead cable/stake 500 meters to rock face/building
Range	
Resolution:	0.01 meters (0.05 feet)
Inclination	
Limits:	± 180 degrees
Inclination	
Accuracy:	± 0.1 degree (typical)
Power	Two AA batteries providing up to 20 hours of use.
Supply:	Do not use “voltage check” cells.